

A Leading Manufacturer of
**CASTORS & TROLLEY
WHEELS**



GROUP OF **Johnson's® castors**

FLOOR LOCKS

FORGED SERIES

MEV SERIES

MSI SERIES

RXH SERIES

SPC SERIES

SPC/FAB SERIES

SPC TTB SERIES

MEDI CR SERIES

TTB SERIES

SS SERIES

L TTB SERIES

RX SERIES

RXM SERIES

RX MEDI SERIES

MEDI PC SERIES

MEDI DW SERIES

WC SERIES

DW SERIES

Rki Castors

Rki Castors (Group of Johnson's Castors) is a leading manufacturer of Castors & trolley Wheels in India. For the last three decades of Experience, the Company offers one of the largest ranges of Castors from 50 mm to 300 mm diameter and the load carrying capacity from 50 Kgs to 10000 kgs(Set of four wheels Castor. Rki Castors (Group of Johnson's Castors) offers a very large range of Pressed Steel Castors and also Stainless Steel Castors of Grade 202 & 304 steel. Besides our standard products, we offer customized solutions to meet any of your specific application or usage. Our manufacturing facility in Gurgaon is spread over 1000 Sq ft. having modern machines, equipment and Tool Room. Our Team of Qualified engineers and Trained Technicians are constantly engaged in ensuring quality that matches the best & economical.

Manufactured under strict quality control and supervision, Rki Castors (Group of Johnson's Castors) offers world class products with innovative indigenous technology which ensures longer life and negligible maintenance or replacement for castors. Rki Castors (Group of Johnson's Castors) are patronized by users in almost every application from material handling, textile, heavy engineering industries, automobile, aviation sectors, hotels, hospitals, electronic equipment to furniture and trolley manufacturers. Depending on the application, the wheels are made of high grades of PU, Nylon, Cast Iron, Rubber and other materials. Rki Castors (Group of Johnson's Castors) are noise-free, roll smoothly, turn effortlessly and are easy to maintain.

Nearly ninety percent components of castors and wheels are produced at our own plant in Gurgaon. We are OEMs to many prestigious industries throughout the country. Without mentioning any reputed names, both in domestic or multi-national space, we can honestly claim that our products are used nationwide. Don't hesitate to ask for our client list, with our offer we would provide you many references which will convince you of our credentials among the best.

Leveraging our infrastructure and a qualified and capable team of professionals, Rki Castors (Group of Johnson's Castors) has moved forward and integrated manufacture of entire range of products for material handling industry. Our wide range of products includes Castors, Trolleys Wheels, and Heavy Duty wheels.

This comprehensive website helps you explore our range of products and make precise choice for your specific needs. In case you need any help, our expert team of technical or marketing official will be happy to provide you not just with the information but also offer a product demonstration which will help you to save a lot of time, trouble and money over a period of time.

We are eager to join hands with you in undertaking development of products specific to your needs and provide Tailor-made solutions. Rki Castors (Group of Johnson's Castors) has a team of business development managers in all major towns of the country, however, if you ever find any difficulty in finding our products.

FLOOR LOCKS

Top Plate fitting medium duty floor locks. While loading or Unloading lock instantly released by slight downward pressure. Large Dia, Non-skid Rubber pad ensure firm grip to un-even ground surfaces. Operating Force does not vary with Load.

MODEL	RETRACED HEIGHT	EXTENDED HEIGHT	HOLE
FL - A	140 MM	170 MM	105 X 80 MM
FL - B	170 MM	206 MM	105 X 80 MM
FL - C	185 MM	222 MM	105 X 80 MM

FINISH
ZINC PLATED WITH
YELLOW PASSIVATED



FORGED SERIES



Available in Various Sizes / type :- Fix / Swivel & Swivel with Brake.

FORGED SERIES

As Forged Steel Castors, ball over the untempered racing of the Castor head are to be in proper functions, for this, we manufacture the series to avoid racing wear-off. Our Castors have bearings which can be replaced at the user end resulting major saving of replacement.

FORGED SERIES - PT						
WHEEL DIA	WIDTH (MM)	TOTAL HEIGHT	PLATE SIZE	HOLE DISTANCE	LOAD CAPACITY	SHEET THICKNESS
100	50	157 MM	150 X 110 MM	115 X 70 MM	250 - 350 KGS	6 + 8 MM
150	50	203 MM	150 X 110 MM	115 X 70 MM	250 - 350 KGS	6 + 8 MM
200	50	248 MM	150 X 110 MM	115 X 70 MM	250 - 350 KGS	6 + 8 MM

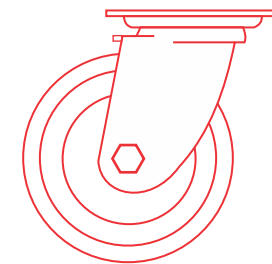
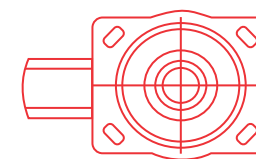

FORGED SERIES - FIX						
WHEEL DIA	WIDTH (MM)	TOTAL HEIGHT	PLATE SIZE	HOLE DISTANCE	LOAD CAPACITY	SHEET THICKNESS
100	50	157 MM	150 X 110 MM	115 X 70 MM	250 - 350 KGS	4 MM
150	50	203 MM	150 X 110 MM	115 X 70 MM	250 - 350 KGS	4 MM
200	50	248 MM	150 X 110 MM	115 X 70 MM	250 - 350 KGS	4 MM

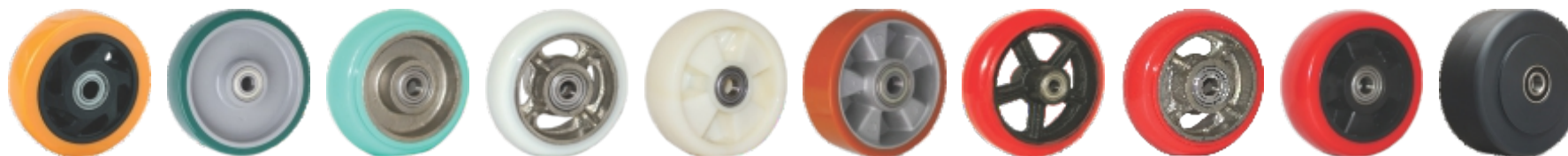
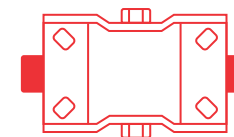

MEV SERIES



Available in Various Sizes / type :- Fix / Swivel & Swivel with Brake.

MEV SERIES

Medium Duty Pressed Steel Castors having double ball bearing in Swivel head with thick threaded King Pin to avoid dust. Fitting available in Plate, Stem (Round/ Square) in Chrome Plated/Powder Coated /Zinc Plating.

Available in Various sizes / Type : Fix / Swivel & Swivel with Brake.

Swivel with Brake manufactured as Front Lock (ON/OFF).

Castors having Iron Bush or double sealed ball bearings .

MEV SERIES - PT						
WHEEL DIA	WIDTH (MM)	TOTAL HEIGHT	PLATE SIZE	HOLE DISTANCE	LOAD CAPACITY	SHEET THICKNESS
100	50	145 MM	133 X 103 MM	105 X 75 MM	150- 175 KGS	3 + 4 MM
150	50	193 MM	133 X 103 MM	105 X 75 MM	150- 175 KGS	3 + 4 MM
200	50	247 MM	133 X 103 MM	105 X 75 MM	150- 175 KGS	3 + 4 MM

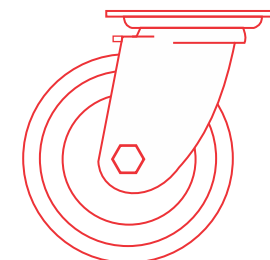
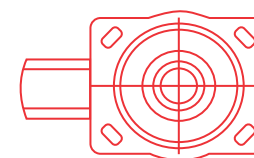

MEV SERIES - FIX						
WHEEL DIA	WIDTH (MM)	TOTAL HEIGHT	PLATE SIZE	HOLE DISTANCE	LOAD CAPACITY	SHEET THICKNESS
100	50	145 MM	133 X 103 MM	105 X 75 MM	150- 175 KGS	3 MM
150	50	193 MM	133 X 103 MM	105 X 75 MM	150- 175 KGS	3 MM
200	50	247 MM	133 X 103 MM	105 X 75 MM	150- 175 KGS	3 MM

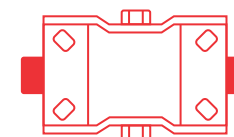

MSI SERIES

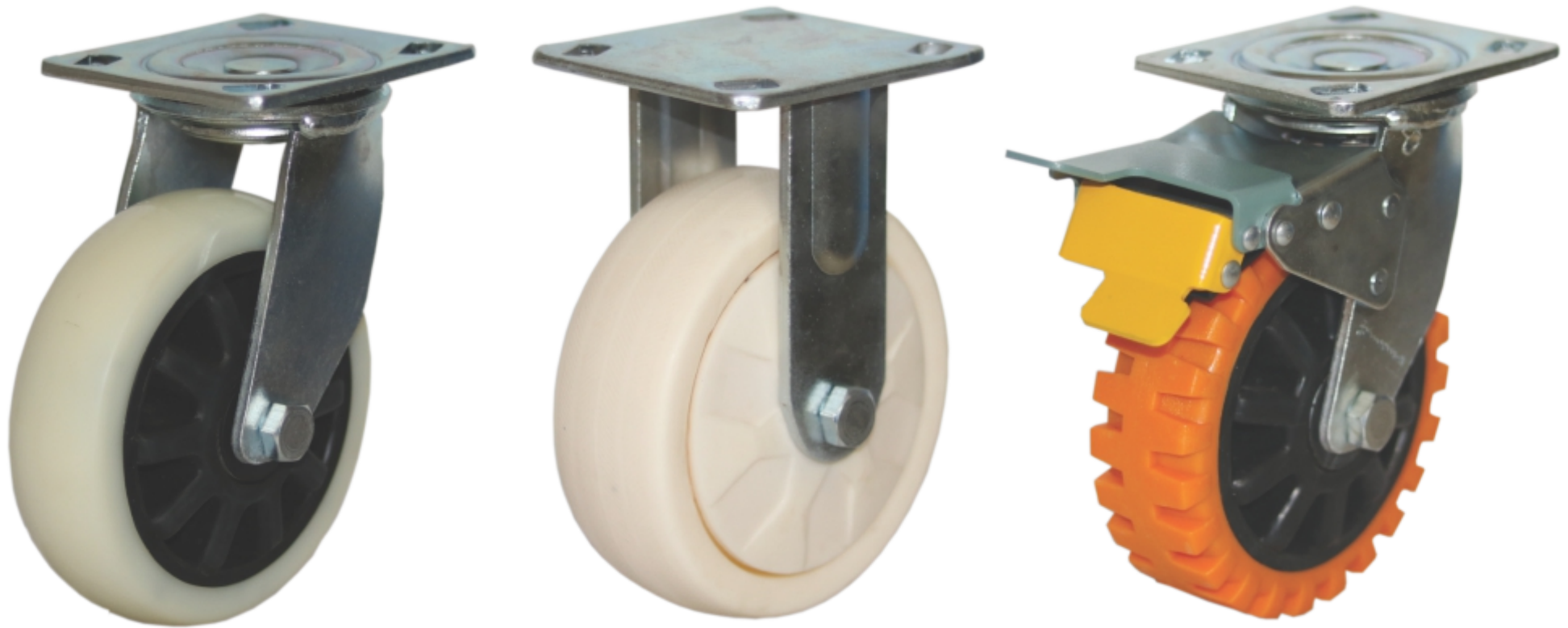

Available in Various Sizes / type :- Fix / Swivel & Swivel with Brake.

MSI SERIES

Quality is Main Essence of our Product & Motto.

To move Ahead your Business, We manufacture Series of Castor Wheels in Medium Duty Fabricated Steel Castors with Double Ball Bearings. Fitting available in Plate & Pipe with Zinc & Powder Coating / as per requirement.

MSI SERIES - PT						
WHEEL DIA	WIDTH (MM)	TOTAL HEIGHT	PLATE SIZE	HOLE DISTANCE	LOAD CAPACITY	SHEET THICKNESS
100	50	142 MM	116 X 100 MM	85 X 70 MM	200 - 300 KGS	5 MM
150	50	192 MM	116 X 100 MM	85 X 70 MM	200 - 300 KGS	5 MM
200	50	242 MM	116 X 100 MM	85 X 70 MM	200 - 300 KGS	5 MM

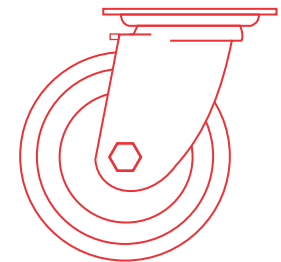
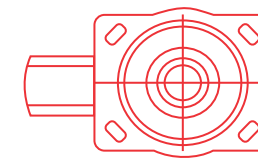

MSI SERIES - FIX						
WHEEL DIA	WIDTH (MM)	TOTAL HEIGHT	PLATE SIZE	HOLE DISTANCE	LOAD CAPACITY	SHEET THICKNESS
100	50	142 MM	116 X 100 MM	85 X 70 MM	200 - 300 KGS	5 MM
150	50	192 MM	116 X 100 MM	85 X 70 MM	200 - 300 KGS	5 MM
200	50	242 MM	116 X 100 MM	85 X 70 MM	200 - 300 KGS	5 MM

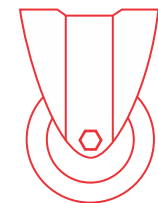
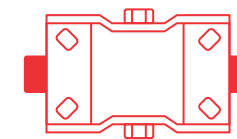

RXH SERIES



Available in Various Sizes / type :- Fix / Swivel & Swivel with Brake.

RXH SERIES

Heavy Duty Pressed Steel Castors having double ball bearing in Swivel head with thick threaded King Pin to avoid dust. Fitting available in Plate , Stem (Round/ Square) in Chrome Plated/Powder Coated /Zinc Plating.

Available in Various sizes / Type : Fix / Swivel & Swivel with Brake.

Swivel with Brake manufactured in Peddle Lock (Back Side) & Front Lock.

Castors having Iron Bush or double sealed ball bearings .

RXH SERIES - PT						
WHEEL DIA	WIDTH (MM)	TOTAL HEIGHT	PLATE SIZE	HOLE DISTANCE	LOAD CAPACITY	SHEET THICKNESS
100	50	152 MM	133 X 118 MM	105 X 75 MM	200 - 250 KGS	4 + 5 MM
150	50	187 MM	133 X 118 MM	105 X 75 MM	200 - 250 KGS	4 + 5 MM
200	50	248MM	133 X 118 MM	105 X 75 MM	200 - 250 KGS	4 + 5 MM

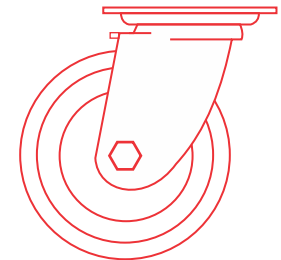
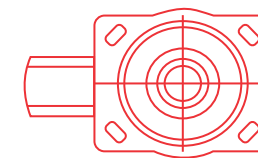

RXH SERIES - FIX						
WHEEL DIA	WIDTH (MM)	TOTAL HEIGHT	PLATE SIZE	HOLE DISTANCE	LOAD CAPACITY	SHEET THICKNESS
100	50	152 MM	150 X 90 MM	115 X 55 MM	200 - 250 KGS	4 MM
150	50	187 MM	150 X 90 MM	115 X 55 MM	200 - 250 KGS	4 MM
200	50	248 MM	150 X 90 MM	115 X 55 MM	200 - 250 KGS	4 MM

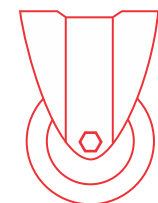
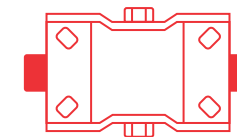

SPC SERIES

Heavy Pressed Steel Spring -Loaded Castors to absorb the shocks/ vibrations during loadings with controlled impact. Top plate & bracket of our Castors are made out of thick sheets to provide strength & ensure that the load is evenly distributed over wheel & spring assembly.

Plate having double ball bearing. Swivel bracket bolted with proper King-Pin to resist the shock loads /Vibrations. Castors fitted with double ball bearings & Axle bolted.



SPC SERIES - PT						
WHEEL DIA	WIDTH (MM)	TOTAL HEIGHT	PLATE SIZE	HOLE DISTANCE	LOAD CAPACITY	SHEET THICKNESS
100	50	200 MM	160 X 120 MM	130 X 80 MM	250 - 350 KGS	5 MM
150	50	213 MM	160 X 120 MM	130 X 80 MM	250 - 350 KGS	5 MM
200	50	257 MM	160 X 120 MM	130 X 80 MM	250 - 350 KGS	5 MM

SPC SERIES - FIX						
WHEEL DIA	WIDTH (MM)	TOTAL HEIGHT	PLATE SIZE	HOLE DISTANCE	LOAD CAPACITY	SHEET THICKNESS
100	50	200 MM	160 X 120 MM	130 X 80 MM	250 - 350 KGS	5 MM
150	50	213 MM	160 X 120 MM	130 X 80 MM	250 - 350 KGS	5 MM
200	50	257 MM	160 X 120 MM	130 X 80 MM	250 - 350 KGS	5 MM

Available in: Powder Coating / Zinc Plated – Yellow passivated finish.



SPC/FAB SERIES

Heavy Fabricated Steel Spring -Loaded Castors to absorb the shocks/ vibrations during loadings with controlled impact. Top plate & bracket of our Castors are made out of thick sheets to provide strength & ensure that the load is evenly distributed over wheel & spring assembly. heavy spring to consider extra load.

Plate having double ball bearing. Swivel bracket bolted with proper King-Pin to resist the shock loads /Vibrations. Castors fitted with double ball bearings & Axle bolted.



SPC/FAB SERIES - PT						
WHEEL DIA	WIDTH (MM)	TOTAL HEIGHT	PLATE SIZE	HOLE DISTANCE	LOAD CAPACITY	SHEET THICKNESS
100	50	141 MM	140 X 115 MM	105 X 80 MM	300 - 400 KGS	6 MM
150	50	191 MM	140 X 115 MM	105 X 80 MM	300 - 400 KGS	6 MM
200	50	241 MM	140 X 115 MM	105 X 80 MM	300 - 400 KGS	6 MM

SPC/FAB SERIES - FIX						
WHEEL DIA	WIDTH (MM)	TOTAL HEIGHT	PLATE SIZE	HOLE DISTANCE	LOAD CAPACITY	SHEET THICKNESS
100	50	141 MM	140 X 115 MM	105 X 80 MM	300 - 400 KGS	6 MM
150	50	191 MM	140 X 115 MM	105 X 80 MM	300 - 400 KGS	6 MM
200	50	241 MM	140 X 115 MM	105 X 80 MM	300 - 400 KGS	6 MM

Available in: Powder Coating / Zinc Plated – Yellow passivated finish.



SPC TTB SERIES

Pressed Steel Spring Loaded Castors made out of thick sheet with taper roller bearing & thrust bearing fitted with grease nipple for lubrications to provide strength & protect from damaging shocks / vibrations caused due to heavier loads & evenly distributed over the wheels & spring assembly , heavy spring to take care for extra load.

Center bolt is forged from EN-8 steel to enhance shock bearing capacity. Kept two ball bearings to ensure noise - less movements.

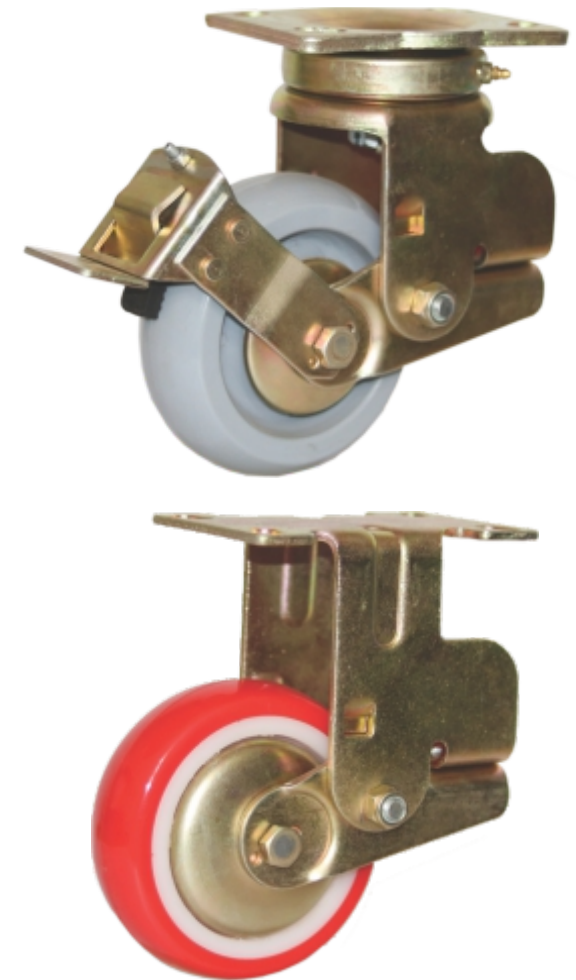

SPC TTB SERIES - PT						
WHEEL DIA	WIDTH (MM)	TOTAL HEIGHT	PLATE SIZE	HOLE DISTANCE	LOAD CAPACITY	SHEET THICKNESS
100	50	207 MM	160 X 115 MM	135 X 80 MM	250 - 500 KGS	6 + 8 MM
150	50	219 MM	160 X 115 MM	135 X 80 MM	250 - 500 KGS	6 + 8 MM
200	50	260 MM	160 X 115 MM	135 X 80 MM	250 - 500 KGS	6 + 8 MM

SPC TTB SERIES - FIX						
WHEEL DIA	WIDTH (MM)	TOTAL HEIGHT	PLATE SIZE	HOLE DISTANCE	LOAD CAPACITY	SHEET THICKNESS
100	50	207 MM	160 X 115 MM	135 X 80 MM	250 - 500 KGS	6 MM
150	50	219 MM	160 X 115 MM	135 X 80 MM	250 - 500 KGS	6 MM
200	50	260 MM	160 X 115 MM	135 X 80 MM	250 - 500 KGS	6 MM

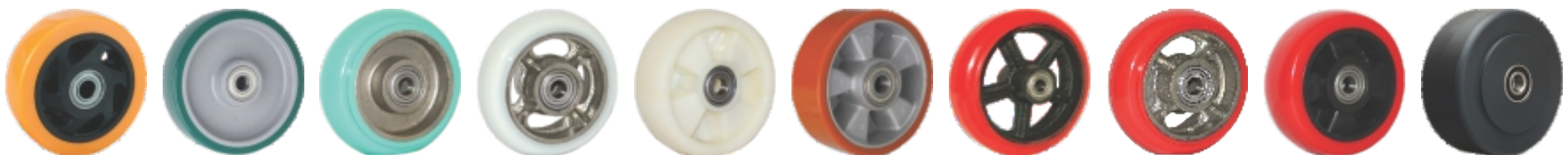

MEDI CR SERIES

Our Medi-CR Series are mainly used for Hospitals Accessories:

Fitting : PLATE, SOLID PLUG & THREAD AS PER REQUIREMENTS.

Accessories : Metal Bracket with Double Lock & Covered with High Density Plastic (Cover).

Wheel : Wheels available in PVC & POLYURETHANE.

MEDI CR SERIES			
WHEEL DIA	WIDTH (MM)	TOTAL HEIGHT	LOAD CAPACITY
100 MM	28	126 MM	40 KGS
125 MM	32	171 MM	55 KGS



TTB SERIES

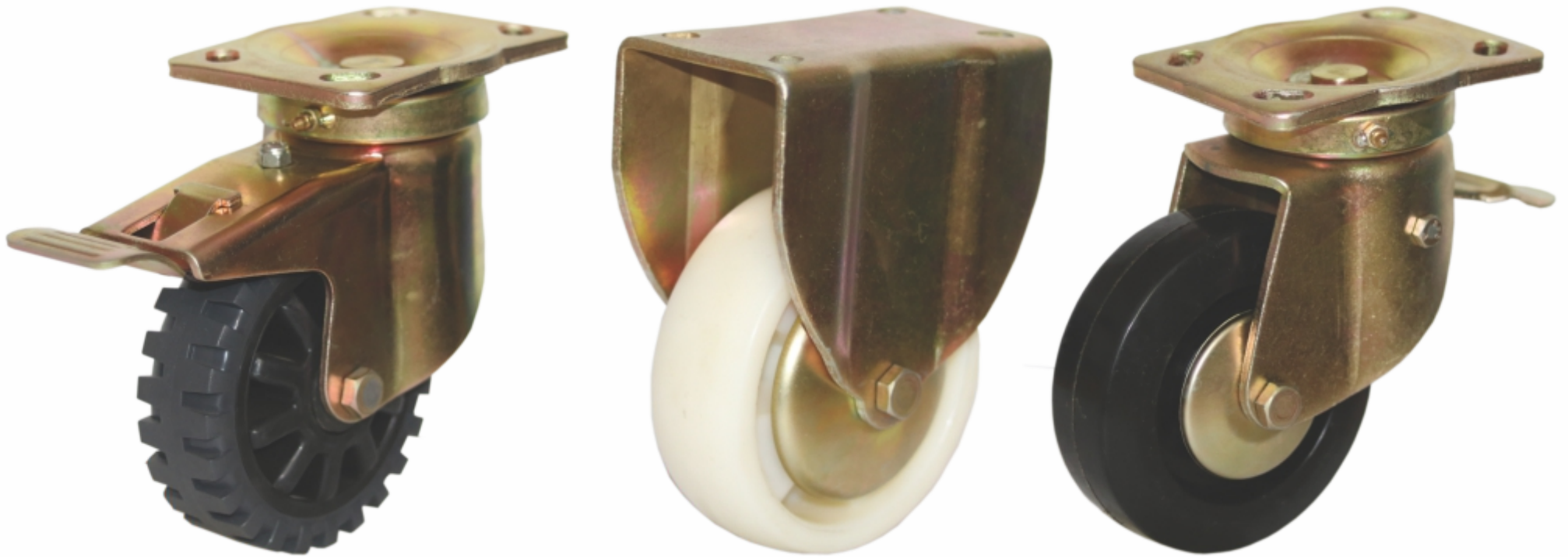

Available in Various Sizes / type :- Fix / Swivel & Swivel with Brake.

TTB SERIES

While manufactured your Product , all require a clean & Proper Platform of floor which indeed is a challenge to minimize the impact Cost of Manufacturing / Maintenance. To achieve the target & Quality of your Product we at **Rki** has introduced TTB Series of Castors which are Long Lasting & Maintenance free. Our Product are specially Designed to Carry Heavy Loads with no impact on Floor/Useance.

We used 6 mm Bracket & 8 mm Plate thickness & also Center Bolt is Forged in EN-8 Steel with Strong/Proper welding to reduce Re-work after using. Swivel head made by us with Taper Roller thrust Ball Bearing for easy Lubrication/use. We Manufacture wide Range of Wheels to roll smoothly. Swivel & Swivel with Brake available in Powder Coating & Zinc Plating.

TTB SERIES - PT						
WHEEL DIA	WIDTH (MM)	TOTAL HEIGHT	PLATE SIZE	HOLE DISTANCE	LOAD CAPACITY	SHEET THICKNESS
100	50	175 MM	150 X 113 MM	115 X 75 MM	300 - 600 KGS	6 + 8 MM
150	50	207 MM	150 X 113 MM	115 X 75 MM	300 - 600 KGS	6 + 8 MM
200	50	260 MM	150 X 113 MM	115 X 75 MM	300 - 750 KGS	6 + 8 MM
250	50	313 MM	150 X 113 MM	115 X 75 MM	300 - 750 KGS	6 + 8 MM

TTB SERIES - FIX						
WHEEL DIA	WIDTH (MM)	TOTAL HEIGHT	PLATE SIZE	HOLE DISTANCE	LOAD CAPACITY	SHEET THICKNESS
100	50	175 MM	150 X 90 MM	115 X 60 MM	300 - 600 KGS	5 MM
150	50	207 MM	150 X 90 MM	115 X 60 MM	300 - 600 KGS	5 MM
200	50	260 MM	150 X 90 MM	115 X 60 MM	300 - 750 KGS	5 MM
250	50	313 MM	150 X 90 MM	115 X 60 MM	300 - 750 KGS	5 MM

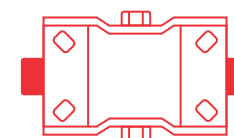
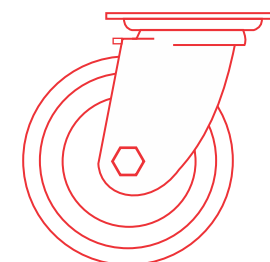
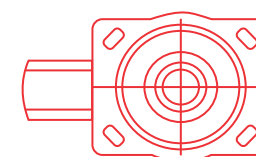

SS SERIES

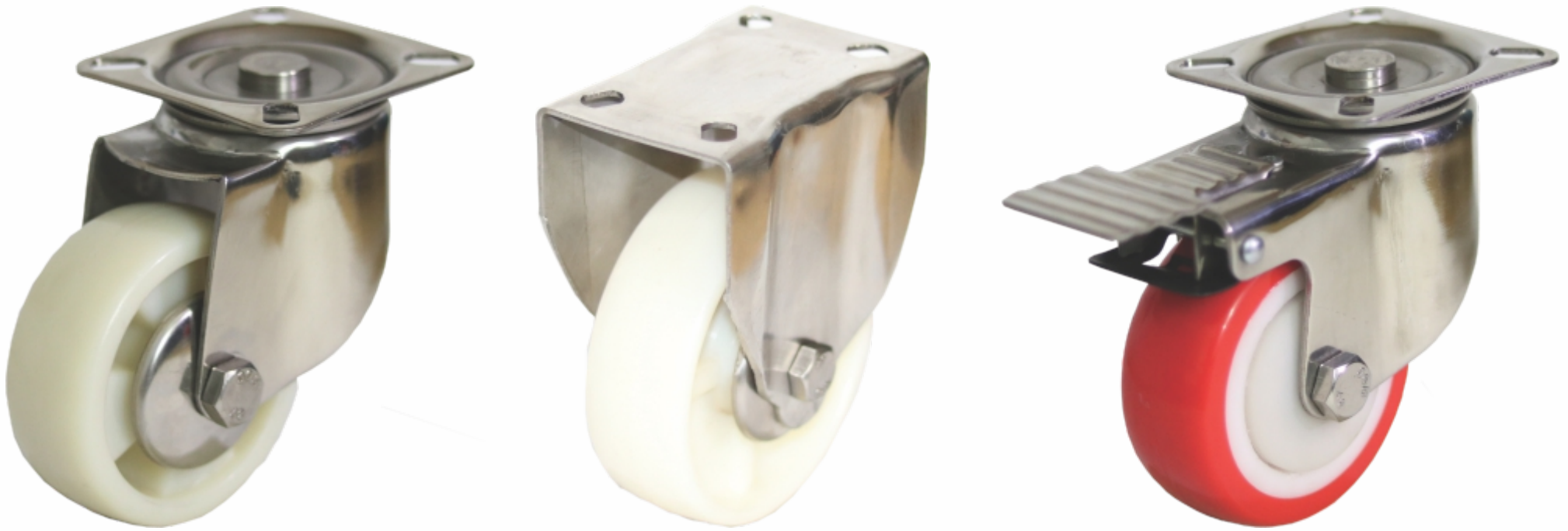

Available in Various Sizes / type :- Fix / Swivel & Swivel with Brake.

SS SERIES

SS SERIES - PT						
WHEEL DIA	WIDTH (MM)	TOTAL HEIGHT	PLATE SIZE	HOLE DISTANCE	LOAD CAPACITY	SHEET THICKNESS
50 MM	22	75 MM	63 X 50 MM	45 X 30 MM	30 KGS	1.5 MM
75 MM	22	97 MM	63 X 50 MM	45 X 30 MM	35 KGS	1.5 MM
75 MM	32	110 MM	96 X 78 MM	75 X 55 MM	60 KGS	2.5 MM
100 MM	32	137 MM	96 X 78 MM	75 X 55 MM	70 KGS	2.5 MM
125 MM	32	157 MM	96 X 78 MM	75 X 55 MM	75 KGS	2.5 MM
100 MM	38	140 MM	94 X 94 MM	70 X 70 MM	90 KGS	2.5 MM
125 MM	38	163 MM	120 X 96 MM	85 X 60 MM	90 KGS	2.5 MM
150 MM	38	192 MM	120 X 96 MM	85 X 60 MM	90 KGS	2.5 MM
200 MM	38	245 MM	120 X 96 MM	85 X 60 MM	90 KGS	2.5 MM

SS SERIES - FIX						
WHEEL DIA	WIDTH (MM)	TOTAL HEIGHT	PLATE SIZE	HOLE DISTANCE	LOAD CAPACITY	SHEET THICKNESS
75 MM	32	110 MM	95 X 67 MM	75 X 45 MM	60 KGS	2.5 MM
100 MM	32	137 MM	95 X 67 MM	75 X 45 MM	70 KGS	2.5 MM
125 MM	32	157 MM	95 X 67 MM	75 X 45 MM	75 KGS	2.5 MM
100 MM	38	140 MM	115 X 78 MM	85 X 45 MM	90 KGS	2.5 MM
125 MM	38	163 MM	115 X 78 MM	85 X 45 MM	90 KGS	2.5 MM
150 MM	38	192 MM	115 X 78 MM	85 X 45 MM	90 KGS	2.5 MM
200 MM	38	245 MM	115 X 78 MM	85 X 45 MM	90 KGS	2.5 MM

Rki introduced SS -SERIES, the Stainless steel version of SS Series are manufactured of pressed steel Castors with Non Corrosive Components to maintain Durability & Having Quality Grade material of 316/304 & 202 steel. Available In wide range of wheels as per the table in Side.

Suitable for application in Hotels/Hospitals/Canteens/Dairy Equipments/Chemical & Pharmaceuticals Industries.

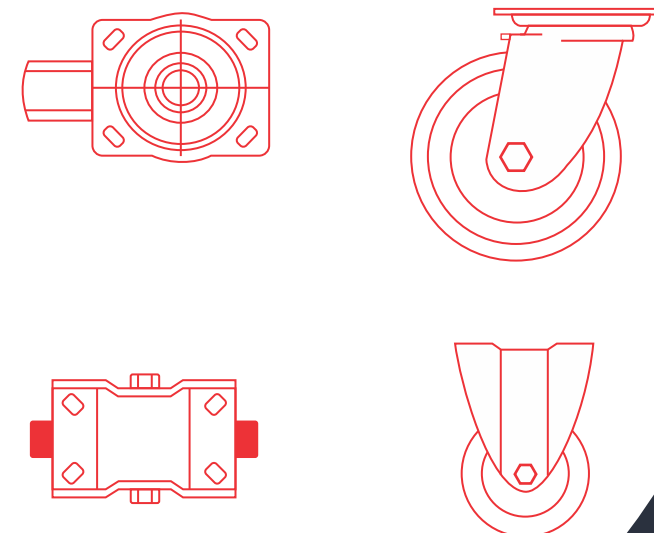

L TTB SERIES



Available in Various Sizes / type :- Fix / Swivel & Swivel with Brake.

L TTB SERIES

We at **Rhi** manufacturer the L-TTB Series in Stainless steel with various Grade 316/304 which are the Highly Suitable for Applications in Pharmaceuticals/Hospital/Hotels & Food Processing Industries etc.

These wheels are very reliable for movement of medium Capacity Load & useful for various applications in medium Load Contents thrust & taper Roller Bearing which can be lubricated through grease nipple for smooth, reliable & Noise less movement & are also required rare maintenance of our wheels.

Rhi also manufactured such type of wheel with MS for Stability of the Products applications.

L TTB SERIES - PT						
WHEEL DIA	WIDTH (MM)	TOTAL HEIGHT	PLATE SIZE	HOLE DISTANCE	LOAD CAPACITY	SHEET THICKNESS
75	38	123 MM	120 X 95 MM	90 X 65 MM	100 - 125 KGS	2.8 MM
100	50	153 MM	120 X 95 MM	90 X 65 MM	100 - 200 KGS	2.8 MM
125	50	173 MM	120 X 95 MM	90 X 65 MM	100 - 125 KGS	2.8 MM
150	50	204 MM	120 X 95 MM	90 X 65 MM	100 - 200 KGS	2.8 MM
200	50	258 MM	120 X 95 MM	90 X 65 MM	100 - 200 KGS	2.8 MM

L TTB SERIES - FIX						
WHEEL DIA	WIDTH (MM)	TOTAL HEIGHT	PLATE SIZE	HOLE DISTANCE	LOAD CAPACITY	SHEET THICKNESS
75	38	123 MM	115 X 80 MM	85 X 45 MM	100 - 125 KGS	2.5 MM
100	50	153 MM	115 X 80 MM	85 X 45 MM	100 - 200 KGS	2.5 MM
125	50	173 MM	115 X 80 MM	85 X 45 MM	100 - 125 KGS	2.5 MM
150	50	204 MM	115 X 80 MM	85 X 45 MM	100 - 200 KGS	2.5 MM
200	50	258MM	115 X 80 MM	85 X 45 MM	100 - 200 KGS	2.5 MM

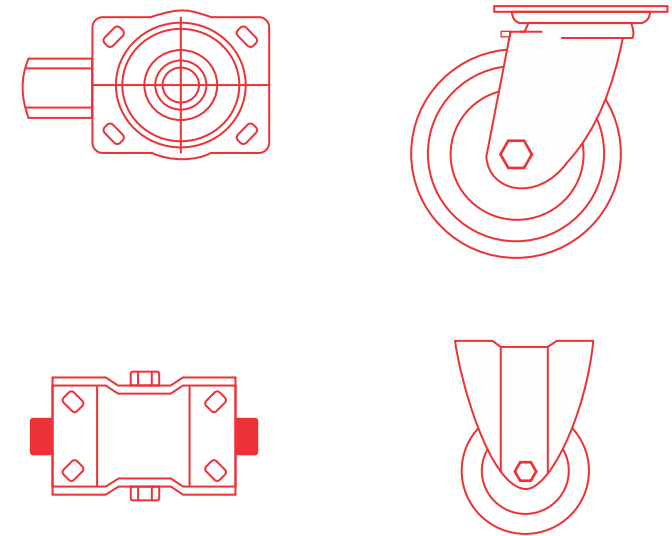

RX SERIES

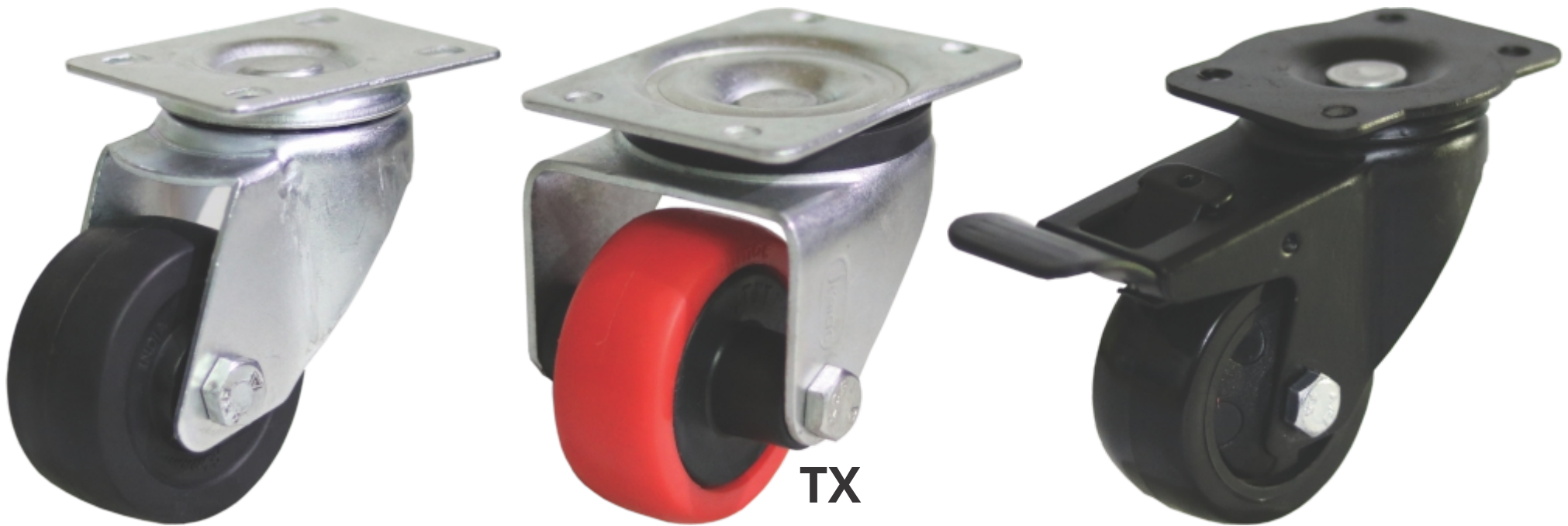

Available in Various Sizes / type :- Fix / Swivel & Swivel with Brake.

RX SERIES

Rki introduced Light Duty Press steel Castor. Majorly used in textile under Card Cans & OTHER Applications.

Finish : Zink Plated.

Fitting : Plate type/Solid Plug/thread ect.

Wheel : Wheels available in PVC/Polypropylene & PU

RX SERIES				
WHEEL DIA	WIDTH (MM)	TOTAL HEIGHT	LOAD CAPACITY	SHEET THICKNESS
50 MM	22	75 MM	25 KGS	1.5 MM
60 MM	20 (TX)	87 MM	25 KGS	2.5 MM
75 MM	22	97 MM	30 KGS	1.5 MM
80 MM	20 (TX)	103 MM	25 KGS	2.5 MM
50 MM	32	74 MM	40 KGS	2.5 + 2.8 MM
62 MM	32	94 MM	50 KGS	2.5 + 2.8 MM
75 MM	32	105 MM	60 KGS	2.5 + 2.8 MM
100 MM	28	122 MM	40 KGS	2.0 MM

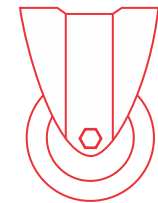
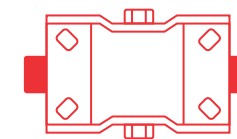
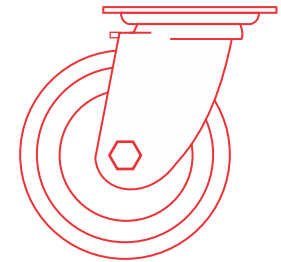
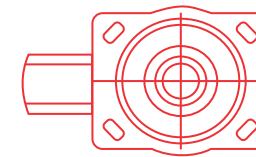

RXM SERIES



Available in Various Sizes / type :- Fix / Swivel & Swivel with Brake.

RXM SERIES - PT

WHEEL DIA	WIDTH (MM)	TOTAL HEIGHT	PLATE SIZE	HOLE DISTANCE	LOAD CAPACITY	SHEET THICKNESS
62 MM	27	90 MM	75 X 57 MM	54 X 40 MM	35 KGS	2 MM
75 MM	27	104 MM	75 X 57 MM	54 X 40 MM	35 KGS	2 MM
75 MM	32	110 MM	96 X 78 MM	75 X 55 MM	60 KGS	2.5 MM
100 MM	27	130 MM	75 X 57 MM	54 X 40 MM	40 KGS	2 MM
100 MM	32	135 MM	96 X 78 MM	75 X 55 MM	60 KGS	2.5 MM
125 MM	32	157 MM	96 X 78 MM	75 X 55 MM	60 KGS	2.5 MM
100 MM	38	136 MM	95 X 95 MM	70 X 70 MM	80 KGS	2.8 MM
125 MM	38	160 MM	120 X 95 MM	90 X 65 MM	80 KGS	2.8 MM
150 MM	38	186 MM	120 X 95 MM	90 X 65 MM	80 KGS	2.8 MM
100 MM	50	136 MM	95 X 95 MM	70 X 70 MM	90 KGS	2.8 MM
150 MM	50	192 MM	120 X 95 MM	90 X 65 MM	90 KGS	2.8 MM
200 MM	50	250 MM	120 X 95 MM	90 X 65 MM	90 KGS	2.8 MM

RXM SERIES - FIX

WHEEL DIA	WIDTH (MM)	TOTAL HEIGHT	PLATE SIZE	HOLE DISTANCE	LOAD CAPACITY	SHEET THICKNESS
75 MM	32	110 MM	95 X 67 MM	75 X 45 MM	60 KGS	2.5 MM
100 MM	32	135 MM	95 X 67 MM	75 X 45 MM	70 KGS	2.5 MM
125 MM	32	157 MM	95 X 67 MM	75 X 45 MM	75 KGS	2.8 MM
100 MM	38	136 MM	115 X 80 MM	85 X 45 MM	90 KGS	2.8 MM
125 MM	38	160 MM	115 X 80 MM	85 X 45 MM	90 KGS	2.8 MM
150 MM	38	186 MM	115 X 80 MM	85 X 45 MM	90 KGS	2.8 MM
100 MM	50	136 MM	95 X 95 MM	85 X 45 MM	90 KGS	2.8 MM
150 MM	50	192 MM	115 X 80 MM	85 X 45 MM	90 KGS	2.8 MM
200 MM	50	250 MM	115 X 80 MM	85 X 45 MM	90 KGS	2.8 MM

RXM SERIES

Rki introduced Light Duty Press steel Castor with Double Ball Bearing in Swivel Head Secured with thick kingpin & Covered with Dust Preventive Side Caps.

Finish : Zink Plated.

Fitting : Plate type.

Wheel : Wheels available in PVC/Polypropylene & PU

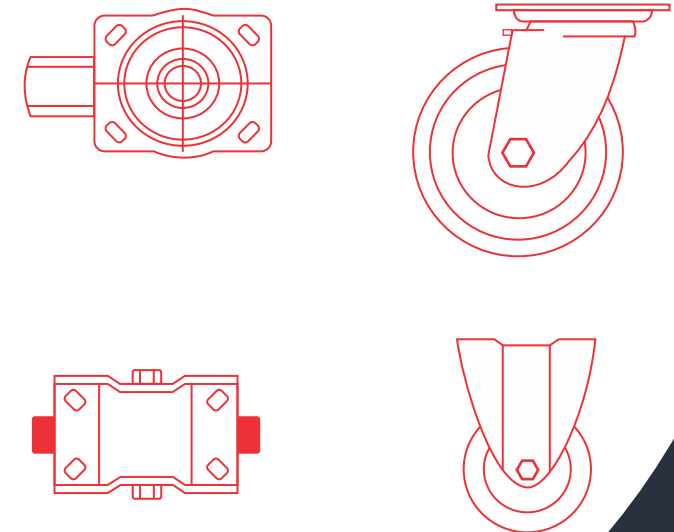

RX MEDI SERIES

R&I introduced Light Duty Press steel Castor. Mainly Used in Hospitals & Hotels trolley etc.

Finish : Zink Plate /Powder Coated/Chrome Plated.

Fitting : Solid Round Plug/thread/Plate type.

Wheel : Wheels available in PVC/POLYURETHENE & RUBBER.

Accessories : Total Lock Available Swivel lock & wheel Movement locked.



RX MEDI SERIES			
WHEEL DIA	WIDTH (MM)	TOTAL HEIGHT	LOAD CAPACITY
75 MM	32	108 MM	50 KGS
100 MM	32	132 MM	65 KGS
125 MM	32	155 MM	65 KGS
150 MM	32	182 MM	85 KGS
200 MM	38	245 MM	80 KGS

MEDI PC SERIES

Our MEDI-PC/MEDI-DW-SERIES medium Duty Castors are mainly used for Hospital Accessories/medical Application made from High Grade Synthetic material.

Fitting Available : Solid plug & Thread as per requirements.

Accessories : Total Lock available

Wheel : Wheels available in PVC/TPE & POLYURETHENE with integrated thread guards Fitted with Precision Ball Bearing.



MEDI PC SERIES			
WHEEL DIA	WIDTH (MM)	TOTAL HEIGHT	LOAD CAPACITY
50 MM	22	82 MM	20 KGS
75 MM	32	114 MM	50 KGS
100 MM	32	138 MM	60 KGS
125 MM	32	164 MM	60 KGS
150 MM	32	190 MM	60 KGS

MEDI DW SERIES

Our MEDI-PC/MEDI-DW-SERIES medium Duty Castors are mainly used for Hospital Accessories/medical Application made from High Grade Synthetic material.

Fitting Available : Solid plug & Thread as per requirements.

Accessories : Total Lock available

Wheel : Wheels available in PVC/TPE & POLYURETHENE with integrated thread guards Fitted with Precision Ball Bearing.

MEDI DW SERIES		
WHEEL DIA	TOTAL HEIGHT	LOAD CAPACITY
75 MM	104 MM	35 KGS
100 MM	127 MM	50 KGS
125 MM	147 MM	50 KGS
150 MM	170 MM	60 KGS



WC SERIES

Rki introduced wheel Chair Accessories. Mainly Used in Hospitals.

Wheel Available : 12" & 26" Chair wheel

Wheel Available : 6" 7" & 8" Surgical wheel.



DW SERIES

We are leading manufacturer of Chair Castor wheels at our esteemed Organization at **R&L**. For immediate references images are attached.

Size's Available : 28 mm, 40mm ,50mm, 62mm, 75mm

Fittings : PLATE/THREAD/KINGPIN/U-PLATE/KNOB TYPE





AIR COOLER WHEEL



CART WHEEL



CENTER LOCKING CASTOR



E-CART WHEEL



GARBAGE WHEEL



i-V STAND



SCAFFOLDING WHEEL



WHEEL CHAIR



ZIGMA WHEEL

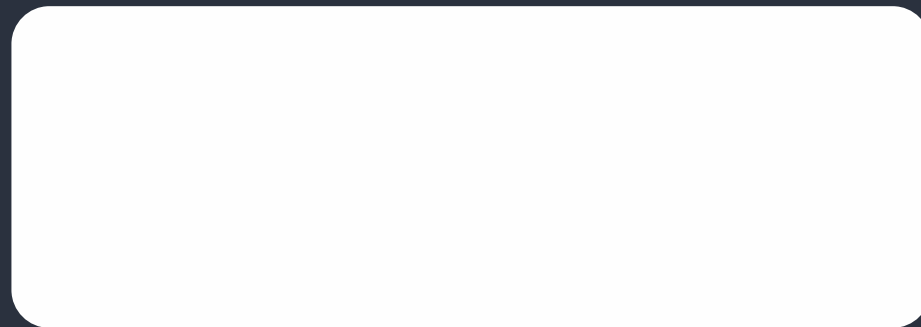

www.rkicastors.com